

Messtische Measuring Stages

MT 60

- Messwege 15 mm, 25 mm oder 50 mm
- kompakte Bauweise
- vorgespannte Präzisions-Kreuzrollenführungen
- verzugsarmes Aluminium
- reflexionsarm, schwarz eloxiert
- zentral oder seitlich angeordnete Messschrauben
- für hochpräzise Positionierung
- XYZ-Montage ohne zusätzlichen Z-Winkel möglich
- measuring ranges 15 mm, 25 mm or 50 mm
- compact design
- preloaded precision crossed roller bearing guides
- deformation-resistant aluminium
- reflection-poor, black anodized
- with central or lateral micrometers
- for high-precision positioning
- XYZ mounting without additional Z angle possible

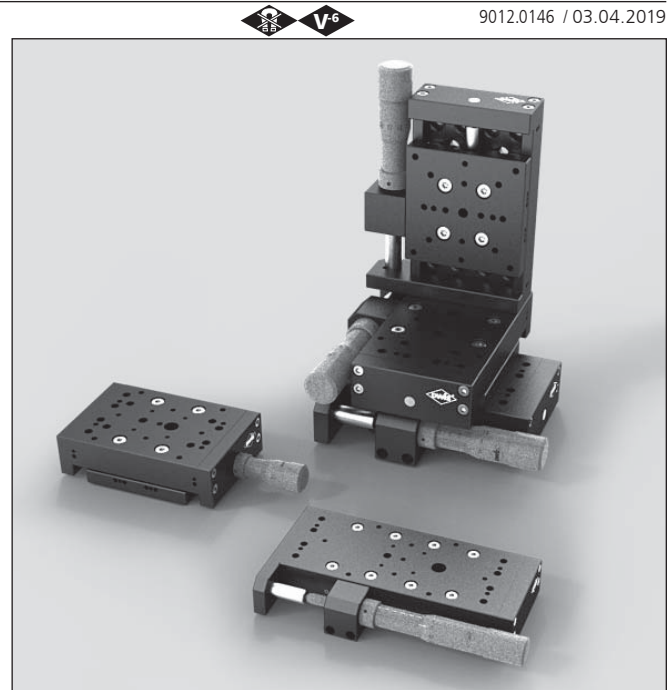

9012.0146 / 03.04.2019

Hinter dem Begriff MT 60 verbirgt sich eine ganze Reihe bewährter Messtische mit 60 mm Breite und Kreuzrollenführungen.

Den unterschiedlichen Anforderungen entsprechend, sind die Messtische MT 60 mit den Stellwegen 15 mm, 25 mm und 50 mm sowie mit zentraler oder seitlicher Messschraube erhältlich.

MT 60 stands for a whole line of proven 60 mm wide measuring stages with crossed roller bearing guides.

According to different requirements, the MT 60 measuring stages are available with measuring ranges of 15 mm, 25 mm and 50 mm and also with either a central or a lateral micrometer.

Bestellangaben/Ordering Information

Messtische/measuring stages

		Typ/type	Bestell-Nr./part no.
X, 15 mm Messweg, mit zentraler Messschraube	X, 15 mm measuring range, with central micrometer	MT 60-15-X-MS	31.063.1581
XY, 15 mm Messweg, mit zentralen Messschrauben	XY, 15 mm measuring range, with central micrometers	MT 60-15-XY-MS	31.063.1582
XYZ, 15 mm Messweg, mit zentralen Messschrauben	XYZ, 15 mm measuring range, with central micrometers	MT 60-15-XYZ-MS	31.063.1583
X, 25 mm Messweg, mit zentralen Messschraube	X, 25 mm measuring range, with central micrometer	MT 60-25-X-MS	31.063.2581
XY, 25 mm Messweg, mit zentralen Messschrauben	XY, 25 mm measuring range, with central micrometers	MT 60-25-XY-MS	31.063.2582
XYZ, 25 mm Messweg, mit zentralen Messschrauben	XYZ, 25 mm measuring range, with central micrometers	MT 60-25-XYZ-MS	31.063.2583
X, 25 mm Messweg, mit seitlicher Messschraube	X, 25 mm measuring range, with lateral micrometer	MT 60S-25-X-MS	31.063.2591
XY, 25 mm Messweg, mit seitlichen Messschrauben	XY, 25 mm measuring range, with lateral micrometers	MT 60S-25-XY-MS	31.063.2592
XYZ, 25 mm Messweg, mit seitlichen Messschrauben	XYZ, 25 mm measuring range, with lateral micrometers	MT 60S-25-XYZ-MS	31.063.2593
X, 50 mm Messweg, mit seitlicher Messschraube	X, 50 mm measuring range, with lateral micrometer	MT 60S-50-X-MS	31.063.5091
XY, 50 mm Messweg, mit seitlichen Messschrauben	XY, 50 mm measuring range, with lateral micrometers	MT 60S-50-XY-MS	31.063.5092
XYZ, 50 mm Messweg, mit seitlichen Messschrauben	XYZ, 50 mm measuring range, with lateral micrometers	MT 60S-50-XYZ-MS	31.063.5093

MT60-15-X-MS

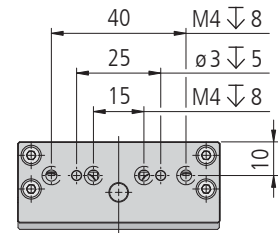
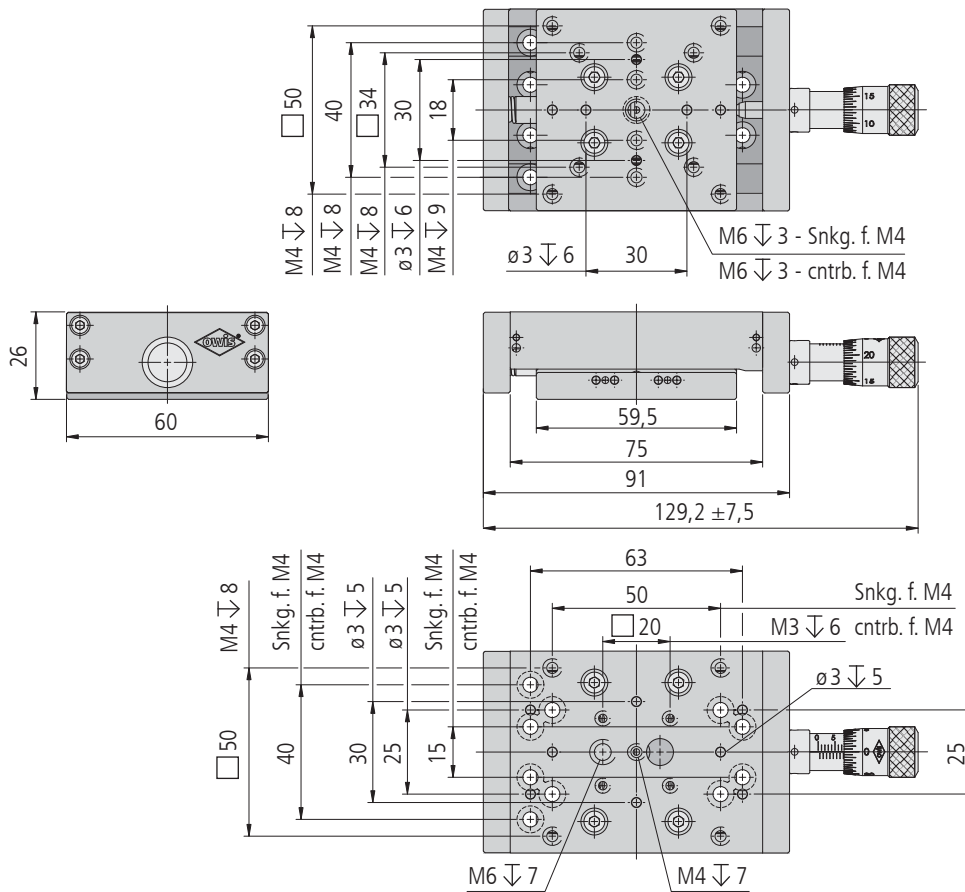

MT60-15-X-MS

MT60-25-X-MS

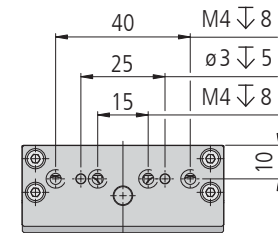
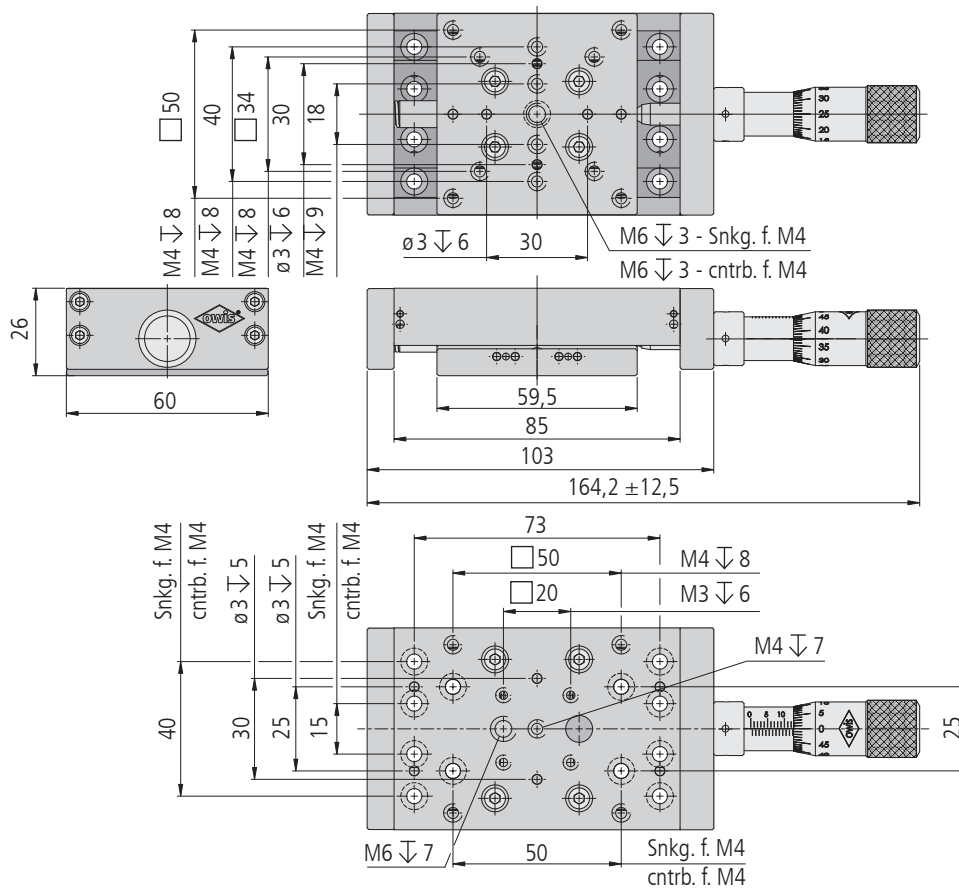

MT60-25-X-MS

MT 60S-25-X-MS

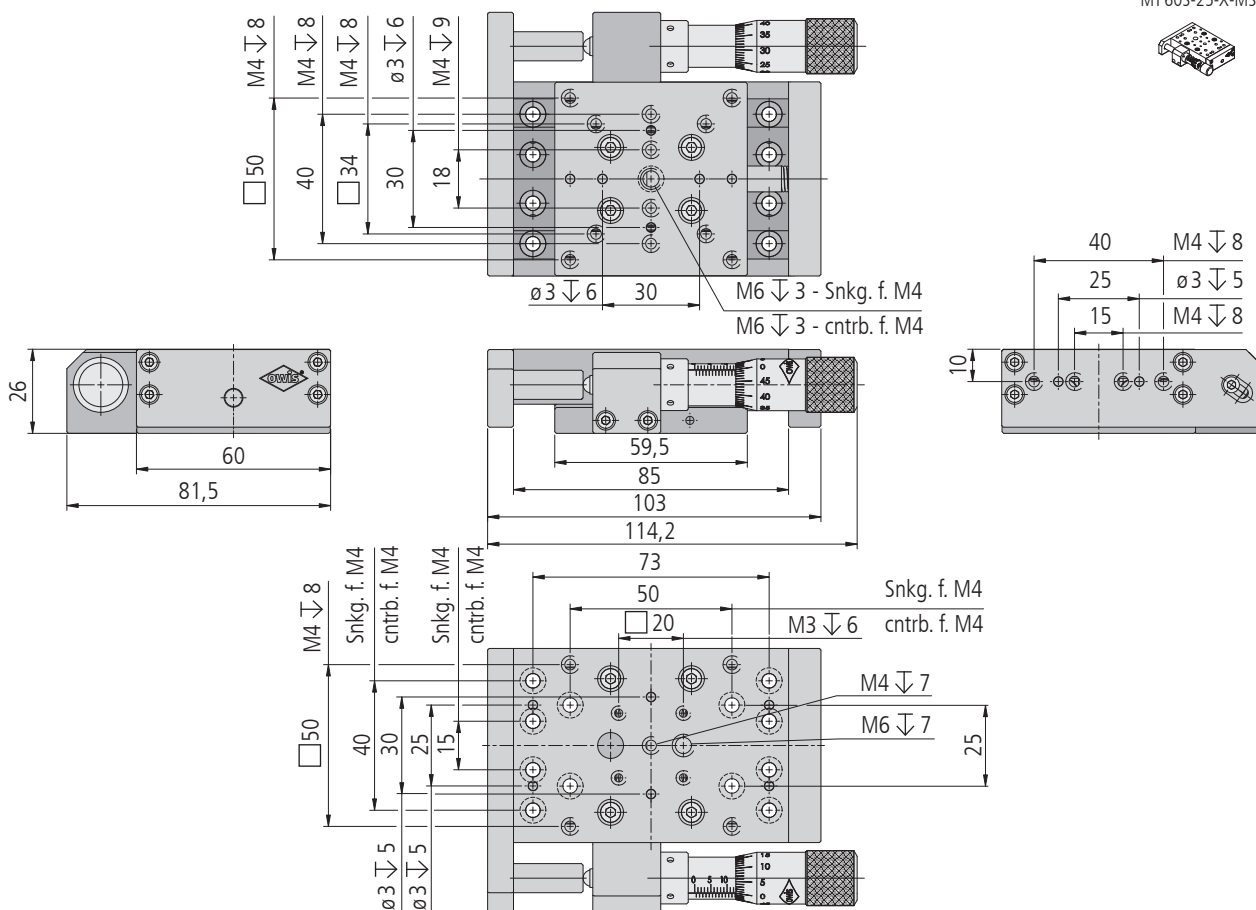

MT 60S-25-X-MS

MT 60S-50-X-MS

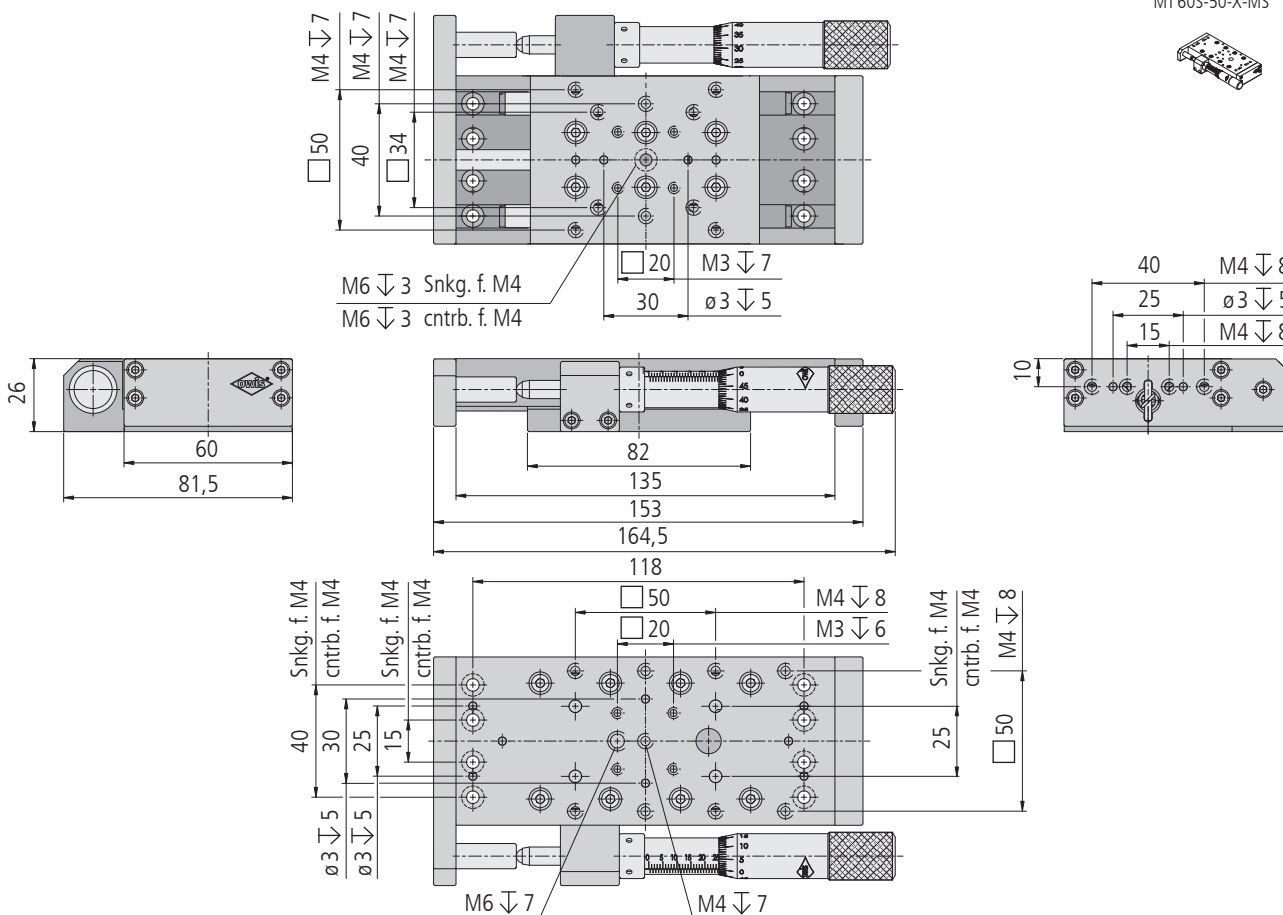

MT 60S-50-X-MS

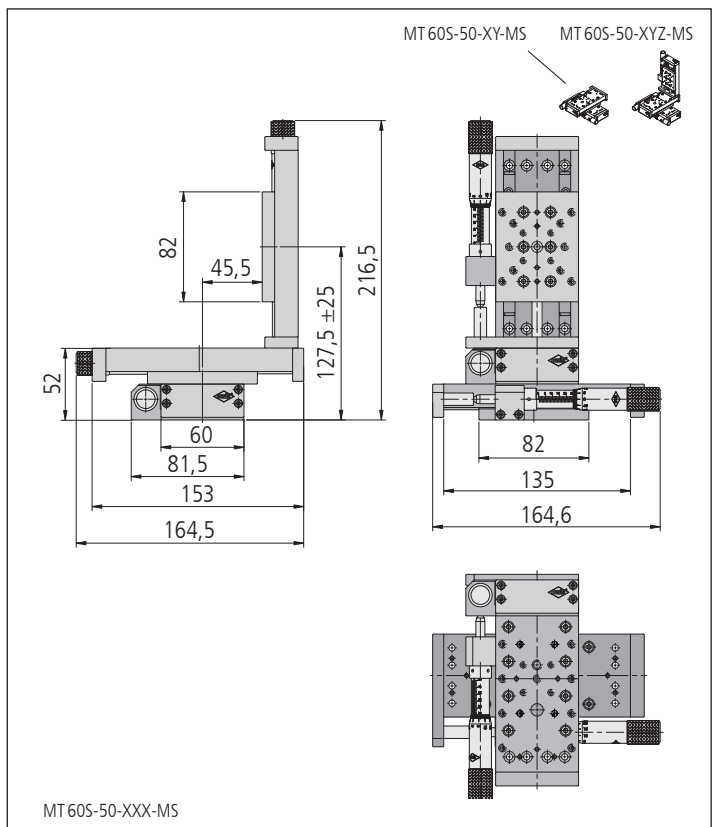
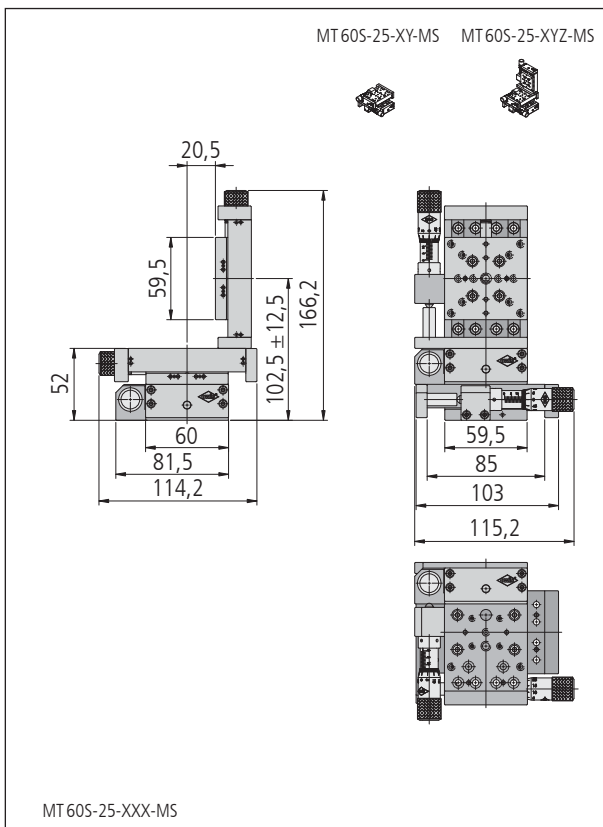
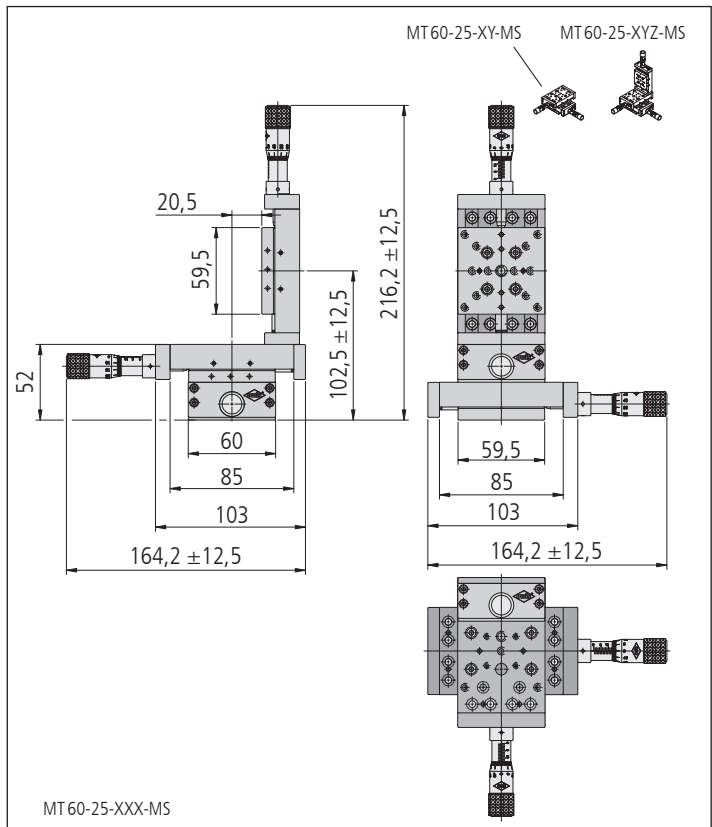
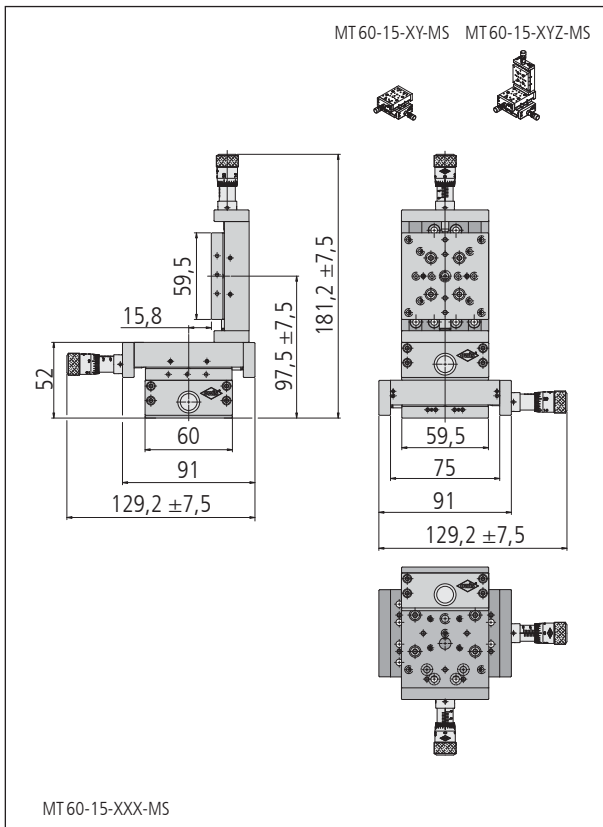

Technische Daten/Technical Data MT60

Messweg	measuring range	15	25	50	mm
Tragkraft	load capacity		max. 90		N
Kippmoment (M _x , M _y , M _z)	tilting moment (M _x , M _y , M _z)	9	max. 7,8	11,5	Nm
Spindelsteigung	spindle pitch	0,25		0,5	mm
Skalenteilung	graduation of scale	5		10	µm
Einstellempfindlichkeit	setting sensitivity	1		2	µm
Rückstellkraft	reset force	11,5 – 21,5	6,4 – 21,5	11,5 – 48	N
Gewicht MT60	weight MT60	400/830/1250	490/970/1460	—	g
Gewicht MT60S	weight MT60S	—	530/1070/1600	740/1500/2250	g