

FastGated-SPAD

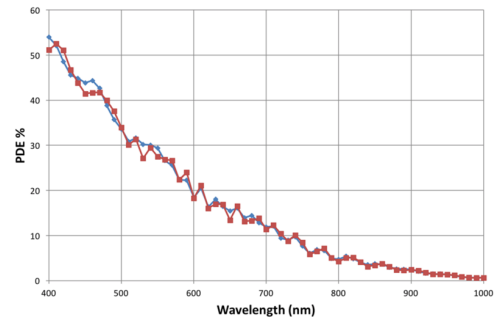

The Fast-Gated Single-Photon Avalanche Diode (SPAD) module is a compact detection module capable of gating a silicon SPAD for wide dynamic range optical measurement. The module includes a fast pulse generator, with gating transitions below 300 ps at repetition rates up to 80 MHz, with fully programmable ON time and excess bias. The differential front-end electronics picks up the avalanche pulse with low timing jitter.

High Photon Detection Efficiency

Up to 50% at 5 V excess bias (V_{EX})

Best-in class Timing Accuracy

< 60 ps FWHM

High Dynamic Range

more than 5 orders of dynamic range magnitude, achievable in few seconds of measurement time

Fully programmable module

gate width, gate repetition frequency, hold-off time SPAD excess bias and temperature

MODULE FEATURES

- Gate rise-time: < 300 ps
- Gate repetition frequency: up to 80 MHz
- Free-running mode available
- Timing jitter: < 60 ps
- Detector active area diameter: 50 μm
- Detection efficiency:
50% @ 400 nm, 5% @ 800 nm

BIOMEDICAL APPLICATION

- Time resolved spectroscopy
- Functional brain imaging
- Optical molecular imaging
- Gated STED
- FLIM - Fluorescence Lifetime IMaging
- FCS - Fluorescence Correlation Spectroscopy

INDUSTRIAL APPLICATION

- Non-Line-of-Sight Imaging
- Metrology by Time of Flight measurements
- Fibre optics characterization
- OTDR – Optical Time-Domain Reflectometry
- LIDAR and ranging

QUANTUM APPLICATION

- Quantum Cryptography
- Quantum Optics
- Single-photon source characterisation

Overview

The FastGatedSPAD module is a compact detection module capable of gating a silicon SPAD for wide dynamic range optical measurement. The module includes a fast pulse generator, with gating transitions below 300 ps at repetition rates up to 80 MHz, with fully programmable ON time and excess bias. The differential front-end electronics picks up the avalanche pulse with low timing jitter. The module can be operated also in free-running mode, with the SPAD always ON.

The main feature of the module is the possibility to increase the Dynamic Range of TCSPC systems thanks to a fast OFF-ON transition. Thus, weak signals can be extracted out of a huge background by enabling the detector only in well-defined time-windows. The good photon detection efficiency and timing resolution are obtained through both the use of epitaxial SPAD and the microwave layout optimized to reduce the effect of voltage oscillations following the fast gate transitions.

The FastGatedSPAD module is controlled through a PC software interface where it is possible to set all the relevant gate parameters (int./ext. trigger, gate frequency, gate width) and all the detector's parameters: temperature, excess bias and hold-off time. In this way, it is possible to adjust the detector performances in terms of DCR, hold-off time and photon detection efficiency, in order to properly match the requirements of the user application.

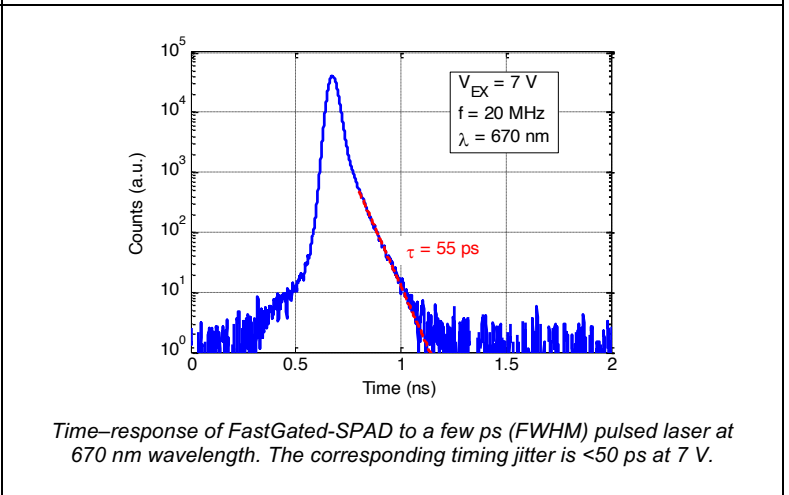
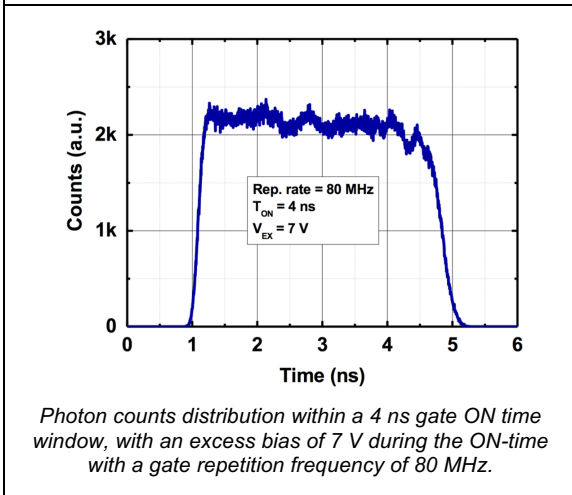
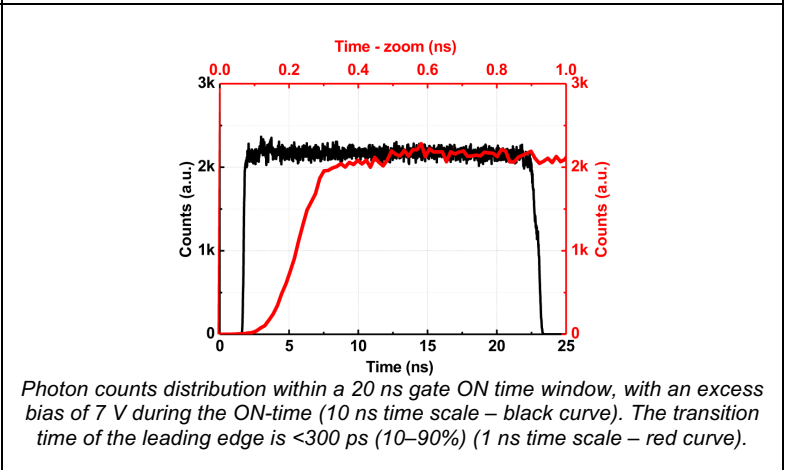
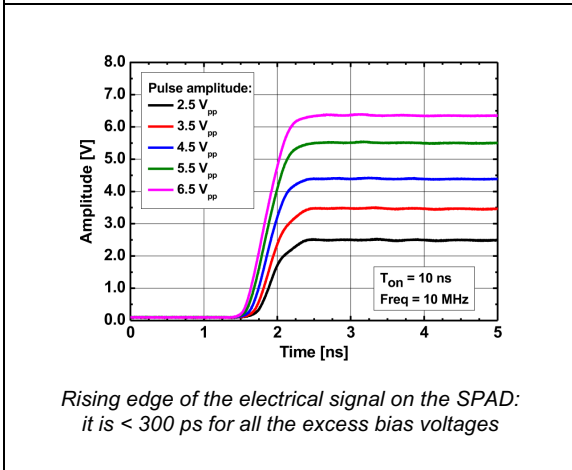
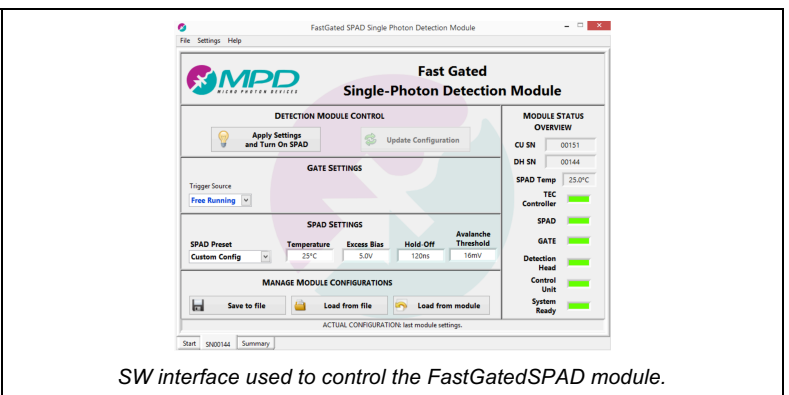
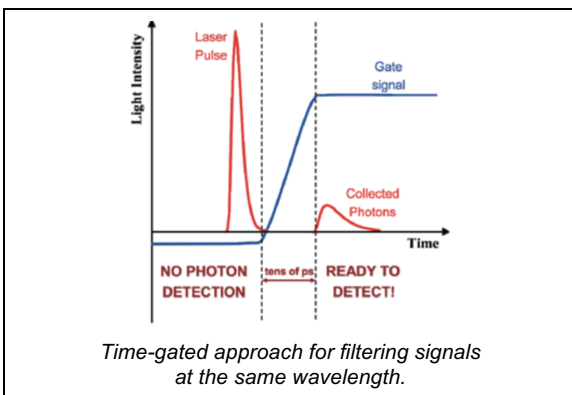

Principle of gated operation

Gated mode operation: the detector is periodically enabled for a short time window called Gate, of duration Gate-Width, whereas it is usually held off at a bias slightly below the breakdown voltage. The gate repetition rate (frequency) is set by a reference signal, the Gate Sync, whose ON time corresponds to the Gate-Width. The actual signal applied to the SPAD is instead the Gate. Initially Gate and Gate Sync are the same. When a photon is absorbed, it triggers the avalanche current which is marked by the raising (in the example below) edge of Photon Output pulse. Once the avalanche is detected, it is immediately quenched. Now Gate and Gate Sync begin to differ due to the hold-off time. The hold-off time is the time during which a detector is kept-off after every avalanche ignition. During the hold-off time, Gate Sync pulses are ignored, and the Gate remains low, keeping the photodetector OFF. The SPAD is enabled again only at the first rising edge of the Gate Sync signal after the end of the hold-off time. The Gate signal, which thus represents the true, non-masked, applied Gate, is buffered and replicated at the control unit front panel: the VALID GATE output.

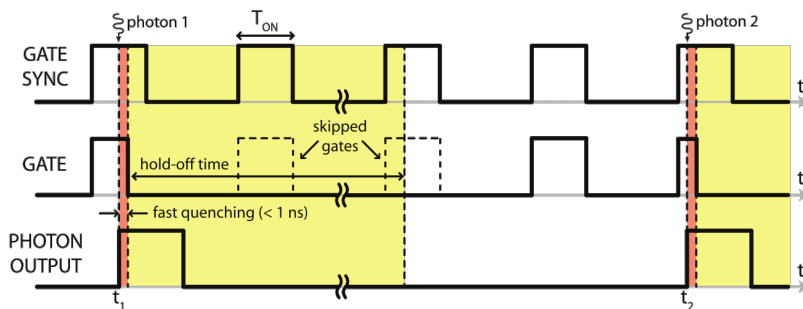

Module Signals: pulse generator (**GATE SYNC**), pulses at the SPAD detector (**GATE**) and photon output signal (**PHOTON OUTPUT**).

Hardware connections

- **PHOTON OUT** output, SMA connector; a digital pulse is generated for each detected photon; the output is a NIM pulse. Pulse's falling edge marks the photon arrival time;
- **VALID GATE** output, SMA connector; outputs which Gate pulses effectively enabled the SPAD (non-masked gate pulses). The pulses are LVTTTL standard;
- **TRIGGER OUT** output, SMA connector; outputs the internal trigger reference signal used to periodically enable the SPAD. The pulses are LVTTTL standard;
- **TRIGGER IN** input, SMA connector; if an external trigger is needed, then the signal must be connected to this input. The external trigger signal can be positive or negative and the internal comparator allows for a programmable threshold.

Module composition and Mechanical Dimensions

The module is composed by two parts connected together through a 2 m wide-bandwidth cable: a Detection Head (DH) which comprises of a CMOS SPAD detector and the related fast electronics, and a Control Unit (CU) which contains the pulse generator, the Peltier controller, communication system and power supplies for the entire module.

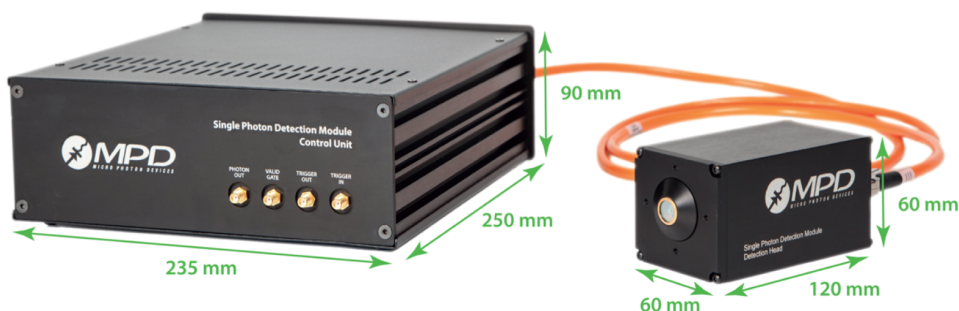

Specifications¹

Parameter	Notes	Min	Typ	Max	Units
Active area diameter			50		µm
Photon Detection Efficiency @ $V_{EX} = 5 V$	@ 400 nm		50		%
	@ 600 nm		20		%
	@ 800 nm		5		%
DCR	At $V_{EX} = 5 V$ and $T = 25 ^\circ C$		< 200		counts/s
Single photon timing jitter (FWHM)	At $V_{EX} = 5 V$		< 60		ps
	At $V_{EX} = 7 V$		< 50		ps
Excess Bias range		3		7	V
SPAD temperature	SW selectable	-10		30	°C
Hold-off time	SW selectable @ 6 ns step	48		1000	ns
	Accuracy	± max (3 ns, 3%)			
Gate rise time	(20% - 80%)		< 300		ps
Gate width	SW selectable @ 40 ps step	2		10	ns
	SW selectable @ 2 ns step	10		500	ns
Gate repetition frequency	External trigger (if $T_{ON} \leq 10 ns$)	DC		80	MHz
	External trigger (if $T_{ON} > 10 ns$)	DC		25	MHz
	Internal trigger	0.0002		80	MHz
PHOTON OUT	NIM output	-800		0	mV
	Required Load (DC)		50		Ω
TRIGGER IN	Amplitude	-2		2.5	V
	Threshold (SW selectable 18 mV step)	-2		2.5	V
	Load Impedance (DC)		50		Ω
	Impulse width	2			ns
TRIGGER OUT VALID GATE	Output levels (± 400 mV)	0		2.9	V
	Required Load (DC)		50		Ω
Supply voltage		100 - 240 VAC @ 50 - 60 Hz			
Optical input		Free space or Fiber connectorized			
System Requirements		USB port and Microsoft Windows® OS			

¹See the user-manual *Specifications* paragraph for the full list of module's specifications. Module designed and built compliant with the European Union Directive 2011/65/CE (also known as RoHS 2).

Ordering information

A standard FastGatedSPAD module is usually shipped with the following parts:

- Control Unit;
- Detection Head (either fiber-pigtailed or windowed);
- Orange wide-bandwidth Cable for Control Unit to Detection Head connection;
- USB key containing the installation software and the user manual in PDF® format;
- SPAD test report;
- Optical table Universal adaptor.

Warranty

A standard legal warranty according to local legislation applies following shipment. Any warranty is null and void if the module case has been opened or if the absolute maximum ratings are exceeded. Specifications are subject to change without any notice. Document version v1.0.4 – May 2020

Contacts

Micro Photon Devices S.r.l, via Waltraud Gebert Deeg 3/F, I-39100 Bolzano, Italy
 T: +39 0471 051212 F: +39 0471 501524
www.micro-photon-devices.com