

Axon

Compact Ultrafast Laser Sources

The Axon series of femtosecond lasers are cost-effective ultrafast sources at discrete wavelengths, that enable a host of applications in imaging, life sciences, inspection, and nano-processing.

Multiphoton Excitation (MPE) microscopy applications are served by key wavelengths at 780 nm, 920 nm, and 1064 nm, for label-free imaging, and all popular fluorescent proteins and calcium indicators.

All models are equipped with dispersion precompensation to provide the shortest pulses at the sample plane. Additionally, each version can be fitted with optional Total Power Control (TPC); built-in modulation for fast power control and flyback blanking.

Integrators benefit from a common, plug-and-play interface with the same form factor for each wavelength. Systems are totally air-cooled with no maintenance requirements, low cost of ownership, and high lifetimes.



FEATURES

- Compact and cost-effective
- Maintenance-free for low cost of ownership
- Air-cooled for flexible system integration
- Plug-and-play common interface
- Dispersion precompensation for optimal non-linear excitation
- Total Power Control (TPC) – optional built-in power control
- HALT-designed for longest lifetimes and high uptime

APPLICATIONS

- Multiphoton Excitation (MPE) Microscopy
- Second Harmonic Generation (SHG) Microscopy
- Two Photon Polymerization
- Nano-Processing
- Semiconductor Metrology
- Supercontinuum Generation
- Terahertz Generation

Specifications	Axon		Axon				Axon			
	780-1	780-1 TPC	920-1	920-2	920-1 TPC	920-2 TPC	1064-1	1064-3	1064-1 TPC	1064-3 TPC
Wavelength ¹ (nm)	780		920				1064			
Average Power (mW)	800	700	1200	2500	1000	2000	1200	3500	1000	3200
Pulse Duration ² (fs)	<150									
Repetition Rate (MHz)	80 ±1 MHz									
Beam Mode	M ² <1.2									
Beam Asymmetry ^{3,4}	0.8 to 1.2									
Beam Diameter ⁴ (mm)	1.2 ±0.2									
Astigmatism (%)	<25									
Power Stability ⁵ (%)	±0.5									
Noise ⁶ (%)	<0.25									
Polarization	>100:1, Vertical									
Dispersion Precompensation ⁷ (fs ²)	-8000 to -23,000 ¹⁰	0 to -15,000	0 to -88,000		0 to -80,000		0 to -28,000		0 to -21,000	
Modulation Rise/Fall Time ⁸ (ns)	NA	<500	NA		<500		NA		<500	
Contrast Ratio ⁹	NA	>1000:1	NA		>1000:1		NA		>1000:1	
Mechanical and Environmental Specifications										
Laser Head Dimensions	212 x 318 x 62 mm (8.35 x 12.52 x 2.44 in.)									
Umbilical Length	7 m (22.97 ft.)									
Laser Power Supply Dimensions	3U, 19" rack mount unit									
Laser Head Mass	4.5 kg (9.92 lbs)									
Operating Temp. Range	19 to 26°C (66 to 79°F)									
Non-Operating Temp.	0 to 40°C (32 to 104°F)									
Relative Humidity (%)	(0-70%) RH, Non-condensing with dew point <20 degs									
Altitude (m ASL)	0 to 2000									
Electrical and Control Requirements										
Power Requirements	100/240 VAC (50/60 Hz), <500 VA									
Control Interface	RS-232 or USB									
Synch Output	BNC, 50% duty cycle, 3.5 V into 50 Ω									
Analog Power Control (V) (optional)	0 to 5									

Notes:

- Center of mass, ±3 nm.
- Assumes sech² deconvolution factor.
- Ratio of waist sizes.
- Measured at beam waist locations.
- Over 2 hours, environment stability ±1°C, after warm-up.
- RMS, 10 Hz to 10 MHz.
- Adjustable via externally accessible fine adjust. Higher values on request.
- 5% to 95% power level.
- Measured at one meter from output port.
- Option available for range starting from 0 fs².

Typical Performance Data

Typical Spectrum: Axon 780

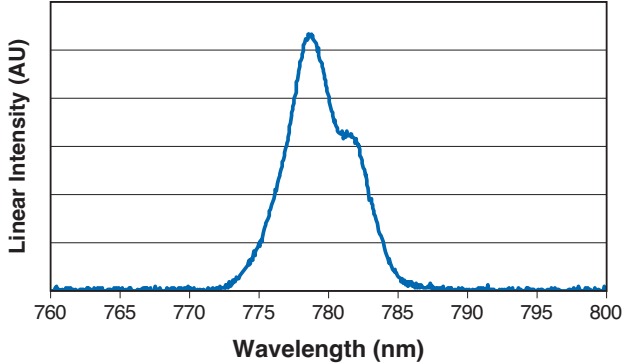

Typical Autocorrelation: Axon 780

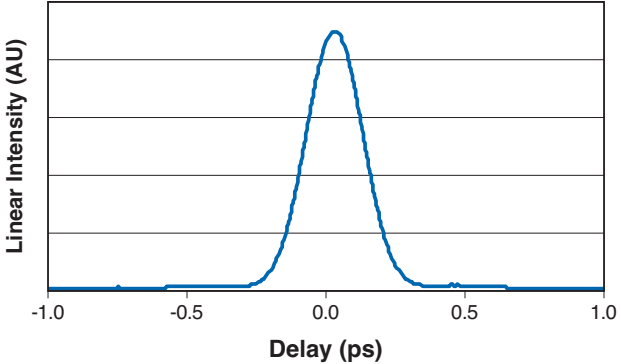

Typical Spectrum: Axon 920

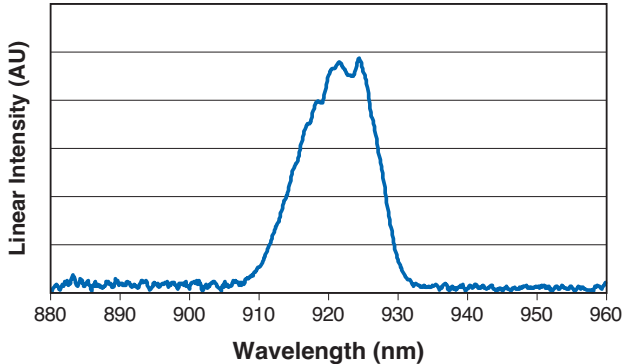

Typical Autocorrelation: Axon 920

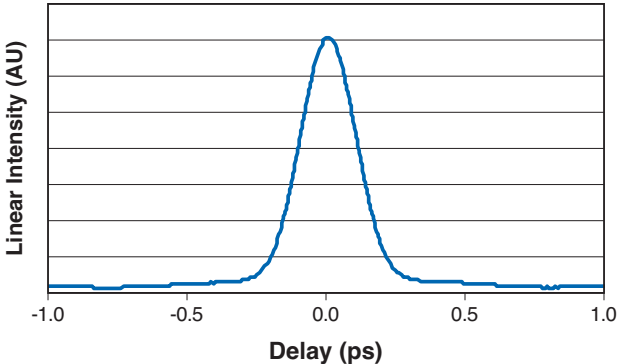

Typical Spectrum: Axon 1064

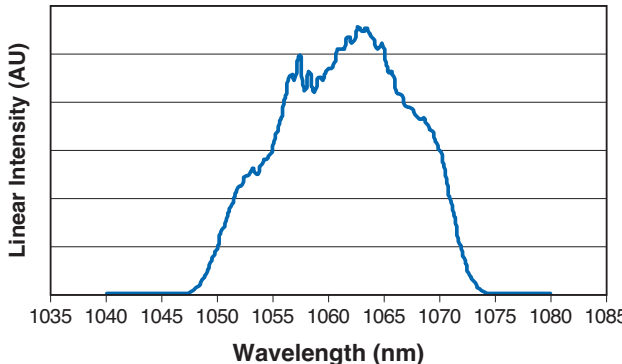

Typical Autocorrelation: Axon 1064

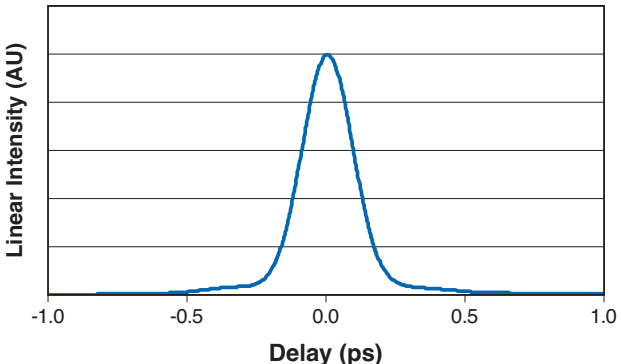

Typical Performance Data

Axon 100-Hour Power Stability

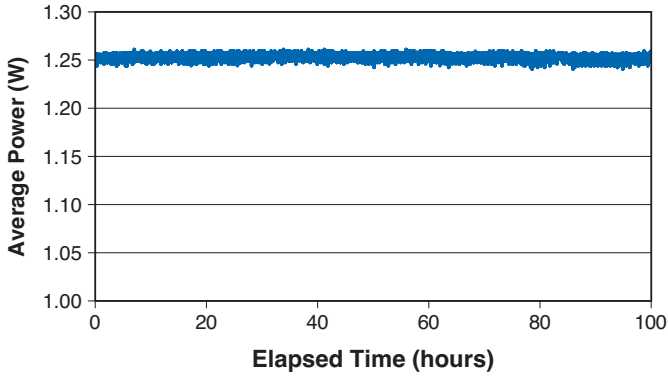

Far Field Beam Profile: Axon

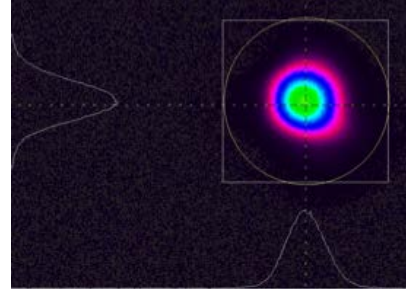

Mechanical Specifications

Axon

Top View

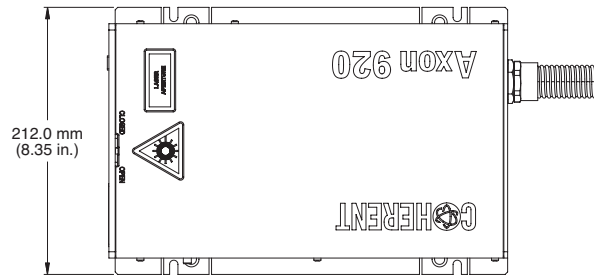

Front View

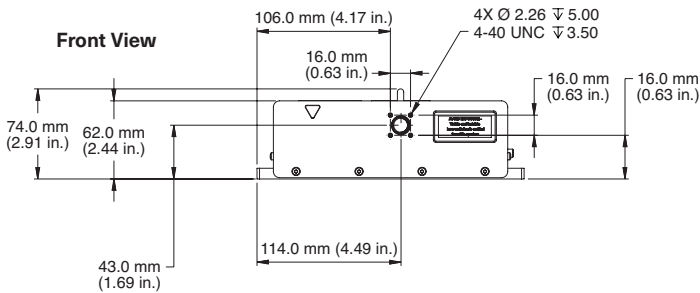

Side View

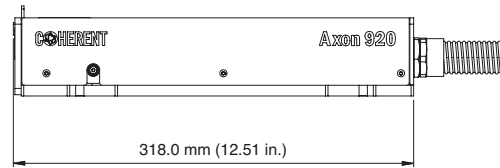

Bottom View

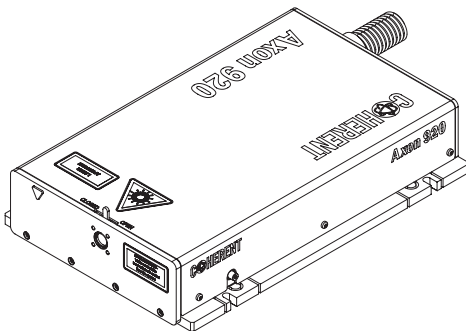
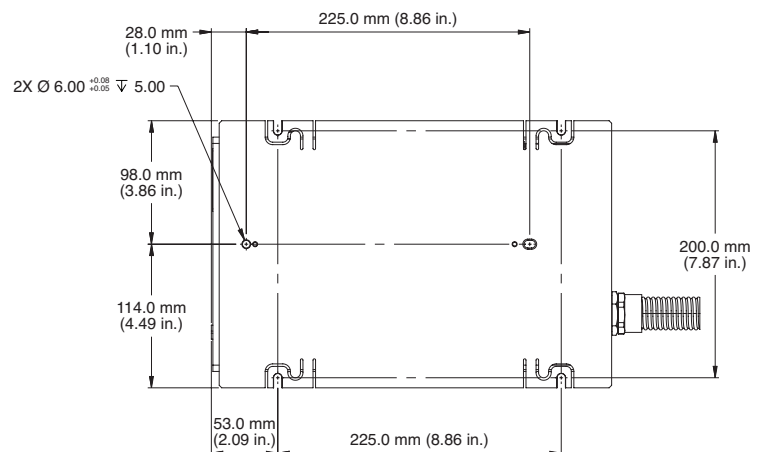

Mechanical Specifications

Axon Controller

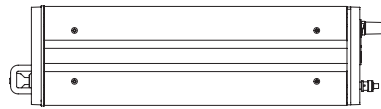
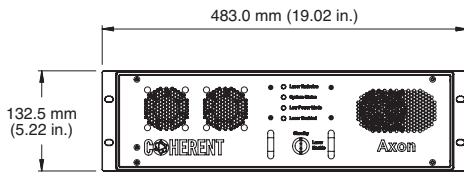
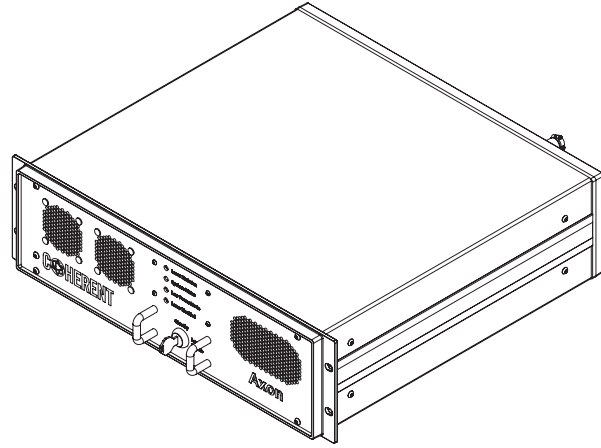
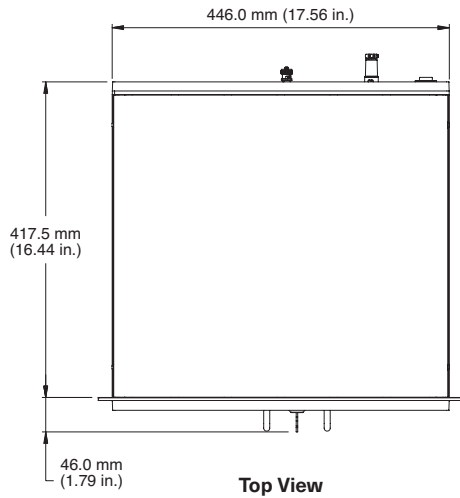

Side View

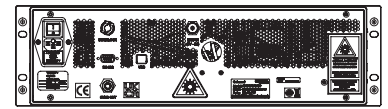

Rear View